

**INSTRUCTIONAL MANUAL**  
**CAT. 62839-10 & 62839-20**  
**Paraffin Wax Dispenser Electrothermal**



**Electron Microscopy Sciences**

P.O. Box 550 ♦ 1560 Industry Road ♦ Hatfield PA 19440

*Toll Free: 1-800-523-5874*

[www.emsdiasum.com](http://www.emsdiasum.com)

[sgkcck@aol.com](mailto:sgkcck@aol.com)

*Tel: 215-412-8400 ♦ Fax: 215-412-8450*

## Introduction & Features

The Wax Dispenser is a large, 7.5L capacity tank designed not only for on-demand delivery of molten wax but also to take up a minimum bench space in the laboratory. With its accurate digital temperature control, it can quickly melt up to 6 kg of pelletized wax at a time. The non-drip lever tap, which is heated via a dedicated heating system, prevents blockages resulting from solidified wax and ensures an even flow of wax. The inner tank has 0.5mm mesh a filter screen which is fitted to prevent coarse particles from blocking the delivery tap. The tank is also fully insulated, thus preventing heat loss from the tank and ensures that the outer surfaces of the tank are safe to touch.

### PACKAGE CONTENTS

Before discarding the packaging check that all parts are present and correct.

The package should contain:

- Wax dispenser with lid
- Country-appropriate power lead
- This instruction manual

### RECORD SERIAL/MODEL NUMBERS







For future reference, record the Serial Number and the Model number here:







Serial Number
Model Number

## Symbols Used in this Instruction Manual

The following symbols are used throughout this manual to identify hazardous conditions or actions that should be observed by the user. These symbols are also on the product or its packaging. When the symbol/s appear beside a statement/paragraph, it is highly advised the user pay particular attention to that instruction in order to prevent injury to self and other people and/or damage to the equipment.

**NOTE:** ALL persons using this equipment should be suitably trained in the use of this product before use.

Symbol	Meaning
	Caution. Risk of danger. See note or adjacent symbol.
	Protective conductor terminal to be earthed. <b>(Do NOT loosen or disconnect.)</b>
	Caution. Risk of electrical shock.
	Recyclable packing material.
	Do NOT dispose of product in normal domestic waste.
	Caution. Hot surface.
	Refer to Instruction Book

Symbol	Meaning
	Mains power switch indicator. Off/On when lamp non-illuminated/illuminated.
	This identifies the Tap Heater Control on the Tap Heater "ON" indication.
	This identifies the Bath Heater on Control and Bath Heater "ON" indicator.
	This identifies Bath Heater Over-temperature indicator.
	Bio-Chemical Hazard. Caution required. Will require decontamination.
	HOT ZONE of this product is the metal tap body area.

## Safety Precautions

This product is designed for safe operation when used with the instructions provided herein.

**NOTE:** Failure to use this equipment as outlined here may compromise your basic safety protection as afforded by the product and may invalidate any warranty/guarantee. Warranty/Guaranty does not cover damage caused by faulty installation or misuse of the equipment.

### Prevention of Fire & Electric Shock



- To prevent risk of fire or electric shock, **DO NOT** open product case without proper authorization. Only qualified Service personnel should attempt to repair this product.
- Replace fuses only with same exact type.
- **NEVER** operate the equipment without connection to earth/ground.
- The Mains power supply must conform to rating as indicated on the data plate on the back of the dispenser.
- The Mains supply voltage must be correctly earthed/grounded in accordance to current legislation and local ordinances.

### General Safe Operating Practice



- **DO NOT** touch the tap body while in use.
- **DO NOT** operate nor handle any part of the product with wet hands.
- Authorized personnel should be properly trained and refer to the Material Safety Data Sheet for the paraffin wax material being used in order to be aware of and take due measures in accordance with the information set forth therein.
- Always follow Good Laboratory Practice (GLP) when using this equipment.
- Follow all company and local jurisdiction codes regarding health and safety procedures applicable to all areas of operation.
- Use care and wear protective gloves.
- Use this equipment **ONLY** for the intended purpose – dispensing melted paraffin wax.
- Position product so it is easy to disconnect from the Mains power supply.
- **DO NOT** use in hazardous atmospheres.
- **DO NOT** use combustible substances near hot objects.
- **DO NOT** lean or reach over equipment without the lid in place.
- **DO NOT** immerse unit in water or fluids.
- **DO NOT** spill chemicals over this product. If spillage does occur, disconnect unit from Mains supply and follow instructions as outlined on next page, under “Spillage and Decontamination”.
- **DO NOT** cover this equipment during use.
- **DO NOT** leave equipment switched ON when empty.
- **DO NOT** leave this or any heating unit unattended during operation.
- **DO NOT** use the tap to lift or carry the unit.
- **ALWAYS** use both hands to carry unit.
- Only use Original Equipment.
- Keep flammable, low flash point substances away from the apparatus.
- The equipment is not spark, flame nor explosion proof and has not been designed for use in hazardous areas in terms of BSEN 60079-14:1997.
- Keep the Mains cord away from the heated tap area.
- At higher tap heater settings, the external surfaces of the tap may exceed 70°C, therefore avoid contact with the surface area of the tap.
- **DO NOT** allow molten wax to accumulate on unit surface.
- **DO NOT** operate tap while wax is cold - this may damage tap.
- **DO NOT** use if unit is empty.
- **DO NOT** apply external heat to the tap.
- **DO NOT** lift this equipment by the tap.
- **DO NOT** move this equipment while still connected to power supply NOR when the wax content is in a hot, molten state.

## Electrical Requirements



- *These operations should only be undertaken by a qualified electrician.*
- *This instrument MUST be grounded.*

### Electrical safety and installation:

- For indoor use only
- Use in a well ventilated area
- Altitude to 2000 m (6500 ft)
- Ambient temperature range 5°C to 40°C (41°F to 104°F)
- Relative humidity should range from 50% (temperature 40°C) to 80% (temperature 31°C)
- Mains supply fluctuations not exceeding 10% of nominal
- Overvoltage category II IEC60364-4-443
- Pollution degree 2 IEC664
- Use with a minimum distance all round of 300 mm (12 in.) from walls or other items

Before connecting, make sure the line supply corresponds to these power requirements:

**Power:** 480W

**Supply requirements:** 110-120 V or 220 - 240 V: ~50/60 Hz



### Special Notes:

- *If in doubt about any of these procedures, consult a qualified electrician.*
- *This equipment must not be flash tested.*
- The unit is provided with three power cables consisting of a UK 3-pin and a “Schuko” 2-pin plug for 230 V installations and a NEMA 5-15 plug for 120 V installations.
- Choose the power cable appropriate for your electrical installation and discard the other. Should neither power cable be suitable for connecting to the power supply, replace the plug with a suitable alternative.
- The appropriate power cable and power adapter combination should be connected to the instrument BEFORE connection to the mains supply. Should the mains lead require replacement, a heat resistant cable of 1.25mm<sup>2</sup> (AWG16) of harmonized code H05VV-F connected to an IEC320 plug should be used.

**NOTE:** Refer to the equipment rating plate to ensure that the plug and fusing are suitable for the voltage and wattage stated. The wires in the mains cable are as follows:

#### **120V**

**BLACK** – HOT/LIVE

**WHITE** – NEUTRAL

**GREEN** – EARTH

#### **230V**

**BROWN** – HOT/LIVE

**BLUE** – NEUTRAL

**GREEN/YELLOW** – EARTH

## Safety Cut-outs

The equipment is protected by a miniature circuit breaker and a temperature cut out.

The miniature circuit breakers are located on the rear of the equipment. In the event of a fault, push back to reset. If the fault continues, please contact your local service representative or the EMS service department at 800.523.5874.

If the temperature cut-out is operated, ensure that the equipment is completely cooled. Identify and rectify the cause of cut-out operation before operating. If the temperature cut-out continues to operate, please contact your local service representative or the EMS service department.

## Operation

**Before Use** – Place the unit on a firm, level surface, and that all four feet on the base of the unit are positioned on the surface firmly. Avoid installation on a slippery surface or on a surface prone to vibration.

**NOTE: Button U is not required in this application.**

1. Power cable must be fully pushed into the power supply socket of the wax dispenser.
2. Connect the mains plug to the electrical supply.
3. Pour the desired quantity of wax into the internal tank. The tank has a maximum capacity of 7.5 L which is large enough to melt 6.0 kg of pelletized histology wax.
4. Turn ON the wax dispenser.
5. Set the desired temperature. Users are recommended to set the temperature 3-4°C above the melting point being used.
  - a. Press **P** then release it (do not hold down **P** for more than 5 seconds).
  - b. The display will show **SP** alternating with the current set temperature.
  - c. To change the set temperature press **▲** to increase the value or **▼** to decrease it. These keys increase or decrease the value one digit at a time, but if the button is pressed for more than one second the value increases or decreases rapidly, and after two seconds pressed, the speed increases even more to allow the desired value to be reached rapidly.
  - d. Exiting the Set mode is achieved by pressing **P** or automatically if no key is pressed for 15 seconds. After that time the display returns to the normal function mode.
6. The heater indicator will illuminate to show heater activity.
7. The equipment will warm up to the desired temperature and temperature rise will be shown on the display.
8. The wax dispenser is designed to melt bulk quantities of pelletized wax in as quick a time as possible. When set at 65°C the instrument will take roughly 90 minutes to fully melt 5kg of pelletized wax, with significant quantities of molten wax available for use after as little as 30 minutes.
9. Wax is delivered by pulling the tap lever forward. The tap has three positions:

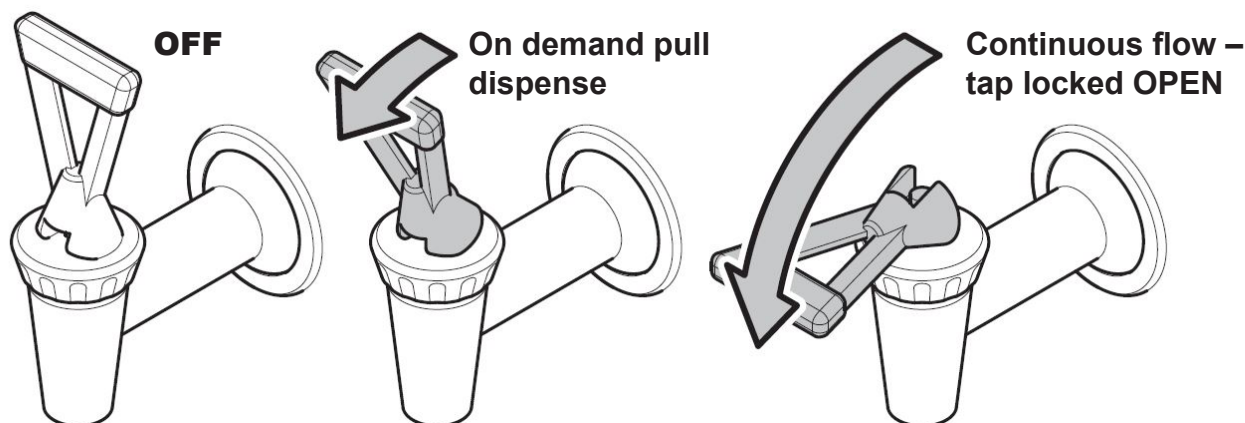
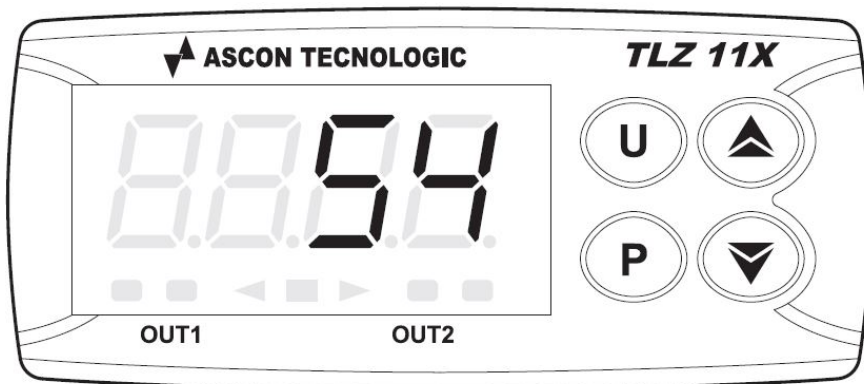

**CAUTION: DO NOT** operate tap while wax is cold - this may damage tap.

## General Maintenance, Servicing and Cleaning

### General Information

This equipment has been designed to give many years of reliable service with proper care in operation. Contamination or general misuse will reduce the effective life of this product and may cause a hazard.



**NOTE: RISK OF ELECTRIC SHOCK.**

Maintenance should only be carried out under the direction of the Authorized Personnel, by a competent electrician. Failure to do so may result in damage to the product and in extreme cases be a danger to the end user.



Do not touch any electrical contacts or open any closure plates.

**ALWAYS** Unplug the unit from the Mains voltage supply and allow it to cool before undertaking any maintenance tasks.

Unit should be cleaned regularly, using the cleaning instructions outlined here. Any other cleaning or decontamination methods, should be checked with your instrument supplier to ensure that the proposed method will not damage the instrument.

**NOTE:** DO NOT use scouring pads, de-scaling agents or solvents to clean any parts of this equipment.

### Cleaning Directions

1. Outer parts that may be cleaned using small quantities of mild detergent or polishes applied with a soft cloth:  
The outer case of the Wax Dispenser, including the control panel.
2. The internal tank can be emptied by locking the delivery tap into the continuous flow position. Any residual wax at the bottom of the tank can be removed using absorbent tissues and wiped clean.
3. The 0.5 mm mesh filter, at the bottom of the tank, can be cleaned in-situ using a toothbrush or similar brush, or lifted out once the bolts are removed for more thorough cleaning using solvents. **NOTE:** Wear protective gloves if removing the filter.
4. Preventative maintenance should include keeping the product clean by protecting it from spillage, contamination or corrosive environments. If in doubt, please confirm that any intended method of decontamination will not damage the equipment by contacting EMS.
5. Inspect unit annually to ensure user safety and to prolong unit life. Parts to include:
  - a. Condition of Power Lead: A visual inspection to ensure the insulation is not damaged and that the correct fuse is fitted.
  - b. Functioning of Heater On Lamp: Heater lamp should be on when the instrument is warming up.
  - c. Condition of the wax dispenser tank and filter (0.5mm mesh): Both tank and filter should be in good condition with no evidence of corrosion and no damage visible to the filter screen.
  - d. Dispensing Tap Seal: The dispensing tap should seal correctly with no occurrence of constantly dripping wax when the tap is not in use. **NOTE:** It is normal for a small quantity of molten wax to remain in the tap after it is closed. This residual wax will drip out, and will be in very small quantities.

**NOTE:** Any repairs or replacement of parts MUST be undertaken by suitably qualified personnel. Only spare parts supplied or specified by EMS or its agents should be used. Fitting of non-approved parts may affect the performance and safety features designed into the instrument.



## In Case of Contamination



**WARNING:** The following procedure is intended as a guide. Should spillage of a toxic or hazardous fluid occur, then additional special precautions may be necessary.

Authorized Personnel need to:

- Carry out appropriate decontamination procedure should the equipment be exposed to contamination.
- Supervise any decontamination methods that take place should any hazardous material become spilt on or inside the equipment, being aware of possible hazards.
- Check with the manufacturer before using any cleaning or decontamination method to make sure the proposed method will not damage the equipment.

**NOTE:** Prior to further use, Authorized Personnel need to check the electrical safety of the unit. Only if all safety requirements are met can the unit be used again. The above procedure is intended as a guide. Should spillage occur with a toxic or hazardous fluid, then special precautions may be necessary.

At the end of its service life, the product must be accompanied by a Decontamination Certificate.

## Specifications

### General Specifications

<b>Safety functions:</b>	Class 1 cut out; Thermal cut out 120°C
<b>Tank cover:</b>	Stainless Steel
<b>Tank material:</b>	Stainless Steel
<b>Tank capacity:</b>	Approx. 7.5 litres
<b>Max. tank capacity:</b>	6 kg
<b>External dimensions:</b>	W 181 x D 499.5 (inc tap) x H 455 mm
<b>Weight:</b>	7.0 kg (without wax); 13.0 kg (with Max. 6 kg of wax)
<b>Temp. display range:</b>	Ambient to 70°C (+/- 1°C at 20°C ambient)
<b>Display resolution:</b>	1°C
<b>Accuracy:</b>	± 1°C
<b>Ceiling temp. setting:</b>	70°C
<b>Display:</b>	Digital Display
<b>Control Sensor:</b>	NTC Thermistor

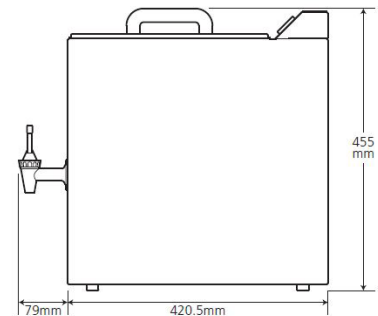
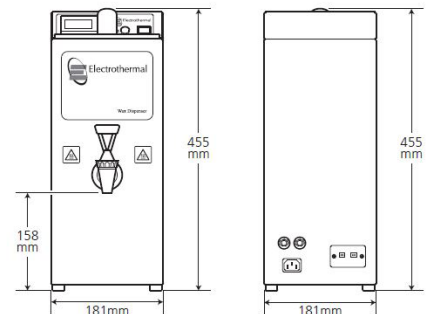

### Electrical Specifications

<b>Total power consumption:</b>	480W
<b>Total power output:</b>	5A
<b>Temperature control:</b>	On/Off
<b>Oven operating temperature range:</b>	Ambient to 70°C (+/- 1°C at 20°C ambient)
<b>Electricity supply:</b>	110 - 120 V ~ 50/60Hz; 220 - 240 V ~ 50/60Hz

## EU Declaration of Conformity

**Product:** Laboratory Equipment

**File Number:** P225

**Object of Declaration:** Wax Dispenser (reference the attached list of catalog numbers)

The object of the declaration described above is in conformity with the relevant Union Harmonization Legislation:

Low Voltage Directive	2014/35/EU
EMC Directive	2014/30/EU
RoHS Directive	2011/65/EC

**This declaration of conformity is issued under the sole responsibility of the manufacturer**

References to the relevant harmonized standards used or references to the other technical specifications in relation to which conformity is declared:

IEC/EN 61010-1:2010 Safety requirements for electrical equipment for measurement, control and laboratory use. Part 1: General requirements.

IEC/EN 61010-2-010:2014 Particular requirements for laboratory equipment for the heating of materials.

IEC/EN 61326-1:2013 Electrical equipment for measurement, control and laboratory use. EMC requirements. Part 1: General requirements.

**Signed for and on behalf of the above manufacturer**

Additional Information	Year of CE Marking: 2018
Place of Issue	Stone, Staffordshire, UK
Date of Issue	03 January 2018
Authorized Representative	Neil Pomeroy
Title	Technical Director
Signature	